

## CONNECT AND PROTECT

### Multiple-Entry Power/Splice/Tee Connection with Junction Box

#### PRODUCT OVERVIEW

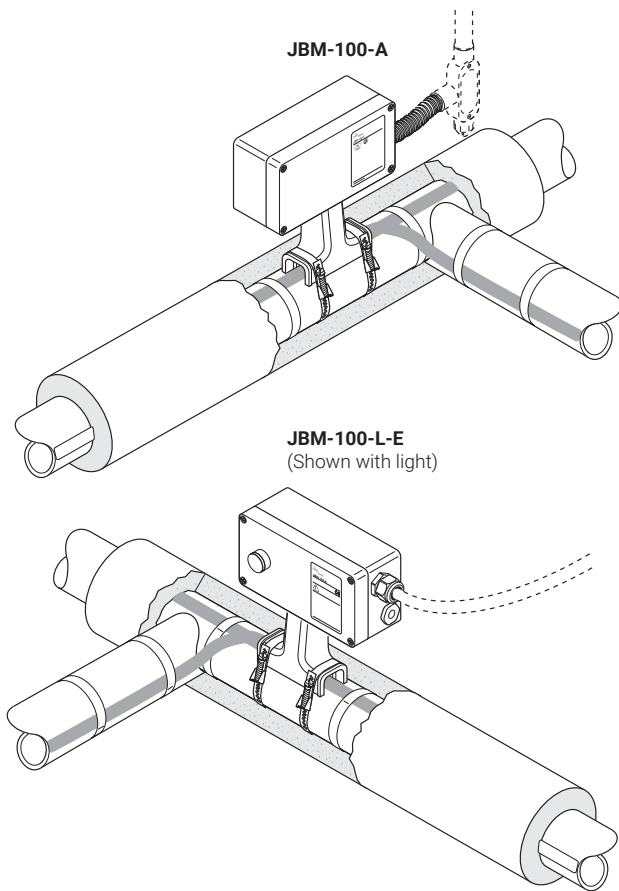

The nVent RAYCHEM JBM-100 kit serves as a power connection, splice, or tee for up to three nVent RAYCHEM brand BTV, QTVR, XTVR, HTV or VPL heating cables. It is approved by FM, CSA, PTB and IEx for use in hazardous locations.

The JBM-100 integrates the functions of connection kits and insulation entries. The rugged stand protects the heating cable and allows for up to four inches (100 mm) of thermal insulation.

The cold-applied core sealer does not require a heat gun or torch for installation, so no hot work permit is necessary. The silicone-free, noncuring sealant allows easy installation and re-entry for maintenance.

Innovative spring clamp terminals provide fast installation and safe, reliable, maintenance-free operation.

Compared with other systems, this connection kit significantly reduces installation time. The kit is offered in three versions, customized for local installation practices. All kits are also available with a plug-in LED light (-L) that indicates when power is supplied to the heating cable circuit.

The kit contains all the necessary materials for a complete installation except for the pipe straps, which must be ordered separately.



## DESCRIPTION

JBM-100-A, A6 JBM-100-L-A	JBM-100-E JBM-100-L-E	JBM-100-EP JBM-100-L-EP
This connection system is certified for use in North America and has one 3/4" through holes for use with 3/4" conduit. One stopping plug is supplied in the kit.	This connection system is certified for use in IEC regions and provides two M25 threaded entries, one stopping plug, and one plastic power cable gland.	This connection system is certified for use in IEC regions and provides two M25 threaded entries, an earthing plate, and an external earthing stud. It is designed for use with armoured cables.







## KIT CONTENTS

1 junction box with terminals 1 stand assembly 3 core sealers 3 green/yellow tubes 1 3/4 in stopping plug assembly 1 light module (for -L only) 2 grommet plugs	1 junction box with terminals 1 stand assembly 3 core sealers 3 green/yellow tubes 1 M25 gland for power cable 8–17 mm in diameter 2 M25 stopping plugs 1 light module (for -L only) 2 grommet plugs	1 junction box with terminals, earth continuity plate, and stud 1 stand assembly 3 core sealers 3 green/yellow tubes 2 M25 stopping plugs 1 light module (for -L only) 2 grommet plugs
---	---	--

**Note:** Order appropriate pipe straps separately (two straps per kit)

## APPROVALS

### Hazardous locations

JBM-100-A JBM-100-L-A	JBM-100-E JBM-100-L-E	JBM-100-EP JBM-100-L-EP
		PTB 20 ATEX 1008 U II 2 G Ex eb mb IIC Gb II 2 D Ex tb mb IIIC Db
 CL I ZN 1 AEx eb IIC T* Gb Ex eb IIC T* Gb ZN21 AEx tb IIIC T*°C Db Ex tb IIIC T*°C Db CL I ZN 1 AEx eb mb IIC T* Gb Ex eb mb IIC T* Gb ZN21 AEx mb tb IIIC T*°C Db Ex mb tb IIIC T*°C Db		IECEx PTB 20.0014U Ex eb mb IIC Gb Ex tb mb IIIC Db
 (1) Class I, Div. 2, Groups A, B, C, D Class II, Div. 1 & 2,  (1) Groups E, F, G Class III Type 4X Temp Code T*	 (3) Ex eb IIC T* Gb Ex eb mb IIC T* Gb	
 Class I, Div. 2 (Zone 2 <sup>(2)</sup> ), Groups A, B, C, D Class I Zone 2 GROUP IIC (HTV heating cable only)	 CL I ZN 1 AEx eb IIC T* Gb Ex eb IIC T* Gb ZN21 AEx tb IIIC T*°C Db Ex tb IIIC T*°C Db CL I ZN 1 AEx eb mb IIC T* Gb Ex eb mb IIC T* Gb ZN21 AEx mb tb IIIC T*°C Db Ex mb tb IIIC T*°C Db	
		* For system T-rating, see heating cable or design documentation. (1) Excluding HTV heating cable. (2) Per C22.1 Table 18 (3) Except KTV NOTE: Protection method "m" or "mb" applies to -L model only

## DIMENSIONS

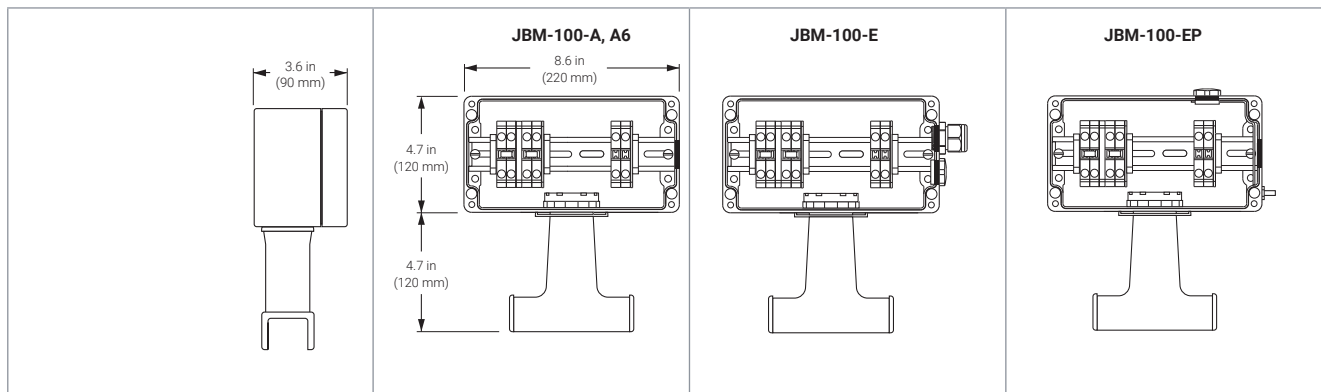

## PRODUCT SPECIFICATIONS

	JBM-100-A, A6 JBM-100-L-A	JBM-100-E JBM-100-L-E	JBM-100-EP JBM-100-L-EP
Heating cable capability	BTV-CR, BTV-CT, QTVR-CT, XTVR-CT, HTV-CT and VPL-CT		
Ingress protection	Type 4X	IP66	IP66
Entries	1 x 0.75 in (1 x 1 in for A6)	2 x M25	2 x M25
Minimum installation temperature	-67°F(-55°C)*	-67°F(-55°C)*	-67°F(-55°C)*
Minimum ambient temperature	-67°F(-55°C)*	-67°F(-55°C)*	-67°F(-55°C)*
Maximum ambient temperature	132°F (56°C)*	132°F (56°C)*	132°F (56°C)*
* For -L lighted kits, the ambient temperature range is -40°F (-40°C) to 104°F (40°C). For non-lighted kits, use a power wire with continuous temperature rating of > 194°F (90°C). For -E and -EP kits use a metallic power cable gland.			
Maximum pipe temperature	500°F (260°C)	500°F (260°C)	500°F (260°C)
Terminals	Spring clamp Ex e 4 line, 2 ground	Spring clamp Ex e 2 phase, 2 neutral, 2 earth	Spring clamp Ex e 2 phase, 2 neutral, 2 earth
Maximum conductor size	8 AWG (A6 to 6 AWG)	10 mm <sup>2</sup>	10 mm <sup>2</sup>
Maximum operating voltage	480 Vac*	480 Vac*	480 Vac*
*JBM-100-L-E, JBM-100-L-EP and JBM-100-L-A are limited to 277Vac.			
Maximum circuit breaker rating*	50 A	40 A	40 A
* For pipe temperatures >150°C and <260°C with XTVR or HTV heating cables, the maximum operating current shall be reduced to maximum 20 A.			

## MATERIALS

Enclosure	Electrostatic charge-resistant glass-filled engineered polymer, black	Electrostatic charge-resistant glass-filled engineered polymer, black	Electrostatic charge-resistant glass-filled engineered polymer, black
Lid screws	Stainless steel	Stainless steel	Stainless steel
Lid gasket	Silicone rubber	Silicone rubber	Silicone rubber
Earth continuity plate	n/a	n/a	Steel, zinc-plated and yellow-chromated

## OPTIONAL LED INDICATOR LIGHT

Color	Red	Green	Green
Voltage rating	100-277 Vac	100-277 Vac	100-277 Vac
Power consumption	< 1 W	< 1 W	< 1 W

## ORDERING DETAILS

<b>Multiple-entry power/splice/tee connection</b>			
Catalog number	JBM-100-A / JBM-100-A6	JBM-100-E	JBM-100-EP
Part number	179935-000 / P000001376	831519-000	986415-000
Weight	4.3 lb (1.95 kg)	1.9 kg (4.2 lb)	2.1 kg (4.6 lb)
<b>Multiple-entry power/splice/tee connection with light</b>			
Catalog number	JBM-100-L-A	JBM-100-L-E	JBM-100-L-EP
Part number	656081-000	395855-000	300273-000
Weight	5.3 lb (2.4 kg)	2.3 kg (5.1 lb)	2.5 kg (5.5 lb)

## ACCESSORIES

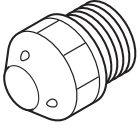
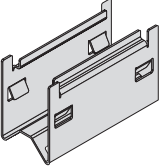
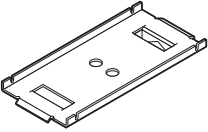
<b>Conduit Drain 3/4"</b>	
Prevents condensate from collecting in the box	
	
Catalog number	JB-DRAIN-PLUG-3/4IN
Part Number	278621-000
Weight	0.074 lb / 36 g
<b>Junction box standoff</b>	
For insulation thickness $\geq 120$ mm & $\leq 180$ mm*	
	
Catalog number	JBM-100-STANDOFF
Part Number	P000003624
Weight	0.599 lb / 272 g
* Consider extra pipe strap length 6-9" (150-225 mm) for attachment	
<b>Small pipe adapter</b>	
Required for stand on pipes $\leq 1$ "	
	
Catalog number	JBM-SPA
Part Number	D55673-000
Weight	0.930 lb / 422 g (Bag of 5 adaptors)

### North America

Tel +1.800.545.6258  
 Fax +1.800.527.5703  
 thermal.info@nVent.com

### Europe, Middle East, Africa

Tel +32.16.213.511  
 Fax +32.16.213.604  
 thermal.info@nVent.com

### Asia Pacific

Tel +86.21.2412.1688  
 Fax +86.21.5426.3167  
 cn.thermal.info@nVent.com

### Latin America

Tel +1.713.868.4800  
 Fax +1.713.868.2333  
 thermal.info@nVent.com



Our powerful portfolio of brands:

**CADDY ERICO HOFFMAN RAYCHEM SCHROFF TRACER**