

CONNECT AND PROTECT

Low profile end seal -Cold applied

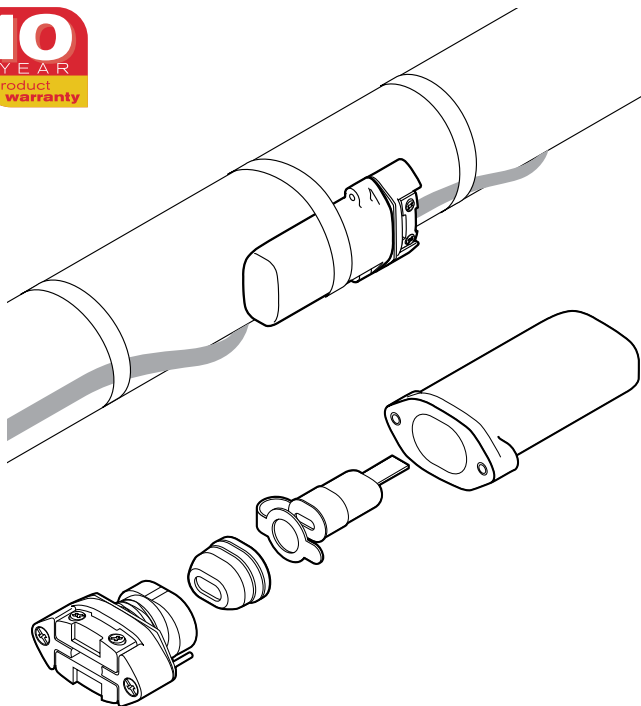

The nVent RAYCHEM E-150 is a cold applied low profile end seal. This universal end seal is designed to fit with all nVent RAYCHEM industrial self-regulating heating cables; BTV, QTVR, XTV and KTV meaning simplified product selection and reduced inventory to stock. It can be used in applications with temperatures ranging from -55°C to 200°C . It is approved for use in hazardous areas.

The unique design of the E-150 suits the demanding requirements of the industrial environment. The low profile housing can be installed on pipes and other surfaces. A spring loaded grommet makes a first seal to maintain a water tight connection while the non-curing sealant (silicone free) used in nVent RAYCHEM's core sealing boot adds a second seal, providing additional protection. The rugged construction of the end seal makes it resistant to impact and suitable for high temperature variations and aggressive chemical exposure. The end seal is re-enterable. The E-150 design provides a safe under the insulation end seal that can be relied upon over time.

The end seal requires no heat source for installation, making maintenance fast and easy. Each kit contains all the necessary materials to do one end termination.

DESCRIPTION

Cold applied end seal for use with BTV, QTVR, XTV and KTV heating cables.

KIT CONTENTS

- 1 end seal enclosure housing
- 1 sealing grommet assembly
- 1 core sealing boot
- 1 identification label
- 1 installation instruction

APPROVALS

Hazardous locations

DEKRA 20ATEX0011U

⊕ II 2 G Ex eb IIC Gb







⊕ II 2 D Ex tb IIIC Db

IECEX DEK 20.0005U





DNV-GL Approvals



When used with BTV, QTVR Heating system: DNV certificate number TAE00000TU

When used with XTV, KTV Heating systems: DNV Certificate number TAE00000TV

	Zone 1 AEx eb IIC T* Gb
	Zone 21 AEx tb IIIC T* °C Db
	Class I, Div. 2, Groups A, B, C, D
	Class II, Div. 2, Groups F, G
	Class III
	Ex eb IIC T* Gb
	Ex tb IIIC T* °C Db

(*) For T-rating, see heating cable or design documentation

	TC RU C-BE.MI062.B.00054/18
	Ex e IIC Gb U Ex tb IIIC Db U
	Ta -55°C...+215°C IP66
	000 "ТехИмпорт"

	Ex e IIC Gb
	Ex tD A21 IP66

DIMENSIONS (IN MM)

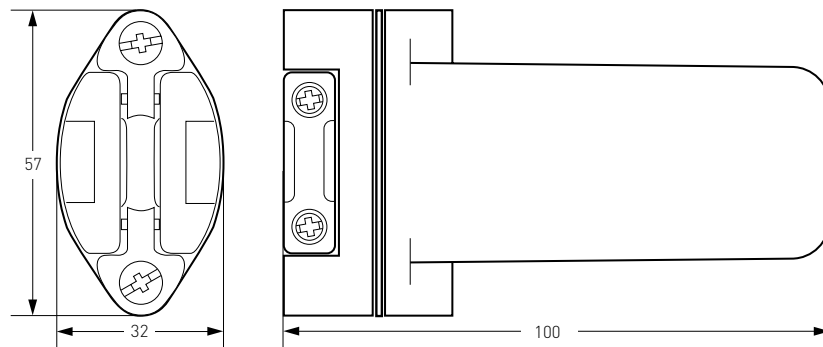

PRODUCT SPECIFICATIONS

Heating cable capability	BTV-CR, BTV-CT, QTVR-CT, XTV-CT, KTV-CT
Ingress protection	IP66
Minimum installation temperature	-55°C
Maximum pipe temperature	150°C POWER ON and 200°C POWER OFF
Operating voltage	277 V

MATERIALS OF CONSTRUCTION

Enclosure, end plate, and shim	Engineering polymers, black
Sealing grommet and core sealer	Silicone rubber
Screws, compression spring, reinforcement plate	Stainless steel

ORDERING DETAILS

End seal	E-150
PN (Weight)	979099-000 (0.3 kg/0.6 lb.)

North America

Tel +1.800.545.6258
Fax +1.800.527.5703
thermal.info@nVent.com

Europe, Middle East, Africa

Tel +32.16.213.502
Fax +32.16.213.604
thermal.info@nVent.com

Asia Pacific

Tel +86.21.2412.1688
Fax +86.21.5426.3167
cn.thermal.info@nVent.com

Latin America

Tel +1.713.868.4800
Fax +1.713.868.2333
thermal.info@nVent.com



Our powerful portfolio of brands:

CADDY ERICO HOFFMAN RAYCHEM SCHROFF TRACER