

# 350 SCREW ON BOX SUPPORT CLIP

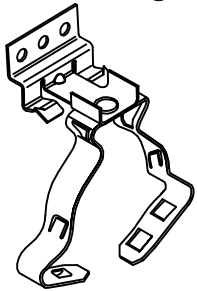

FIG 2

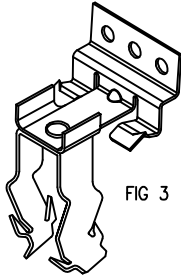

FIG 3

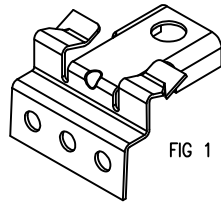
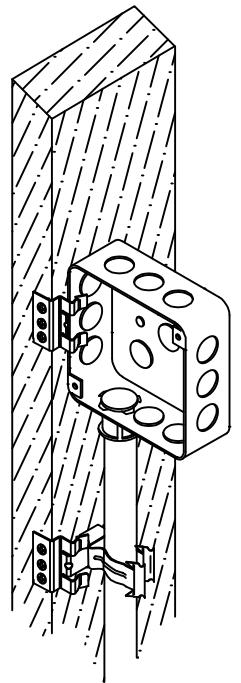
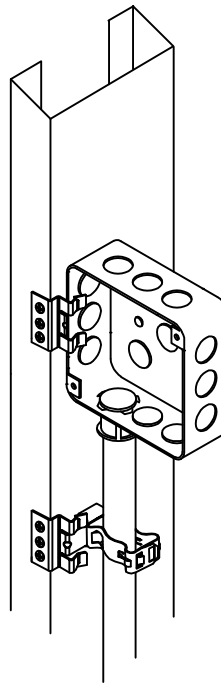
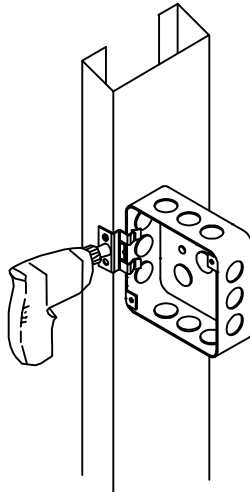
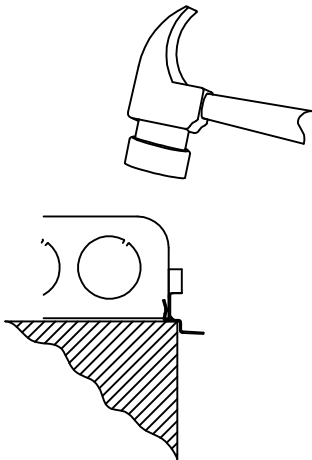

FIG 1

PART NUMBER	FIG. NO.	DESCRIPTION
350	1	4" ELECTRICAL BOX TO METAL STUD
350812M	2	1/2" OR 3/4" CONDUIT TO METAL STUD
35016M	2	1" CONDUIT TO METAL STUD
3508P	3	1/2" CONDUIT TO METAL STUD
35012P	3	3/4" CONDUIT TO METAL STUD
35016P	3	1" CONDUIT TO METAL STUD



**WARNING**

1. ERICO products shall be installed and used only as indicated in ERICO product instruction sheets and training materials. Instruction sheets are available at [www.erico.com](http://www.erico.com) and from your ERICO customer service representative.
2. ERICO products must never be used for a purpose other than the purpose for which they were designed or in a manner that exceeds specified load ratings.
3. All instructions must be completely followed to ensure proper and safe installation and performance.
4. Improper installation, misuse, misapplication or other failure to completely follow ERICO's instructions and warnings may cause product malfunction, property damage, serious bodily injury and death.
5. Products that are manufactured using spring steel components shall be used only in a non-corrosive indoor environment.
6. All pipe supports, hangers, intermediate components and structural attachments must **ONLY** be used as described herein and are **NEVER** to be used for any other purpose.

NOTE: All load ratings are for static conditions and do not account for dynamic loading such as wind, water or seismic loads, unless otherwise noted.

The customer is responsible for:

- a. Conformance to all governing codes.
- b. The integrity of structures to which the products are attached, including their capability of safely accepting the loads imposed, as evaluated by a qualified engineer.
- c. Using appropriate industry standard hardware as noted above.

SAFETY INSTRUCTIONS: All governing codes and regulations and those required by the job site must be observed. Always use appropriate safety equipment such as eye protection, hard hat, and gloves as appropriate to the application.

CADDY, CADWELD, CRITEC, ERICO, ERIFLEX, ERITECH and LENTON are registered trademarks of ERICO International Corporation.

